



TOUGH TRAC™

MID ANGLE PORTRAIT SYSTEM 2011



The TOUGH TRAC solutions for a simple bolted ground mount design. Our Mid Angle System can be mounted to the ground or concrete curbs to be used as ballasts.

Tough Trac Mid Angle System is re-designed to mount more panels in Portrait. The Mid Angle Portrait System mounts in a fixed 30 degree tilt.

Design features include a simple 3 part section, a rear Vertical support and 2 base stands. A Rear Cross Brace provides support for lateral movement. Using our Standard Rail, spacing is 96" between sections.

Aggressively priced, this Mid Angle Portrait System offers superior aesthetics, durability and will provide long term performance for your ground mount installation.



FACTORY PRODUCTION FACILITIES: Made in the USA & China

VISIT US ONLINE AT WWW.TOUGHTRAC.COM

©COPYRIGHT 2009 TOUGH TRAC™. TRADEMARK BELONGS TO THEIR RESPECTIVE OWNERS. ALL RIGHTS RESERVED.



Mid Angle Portrait Section

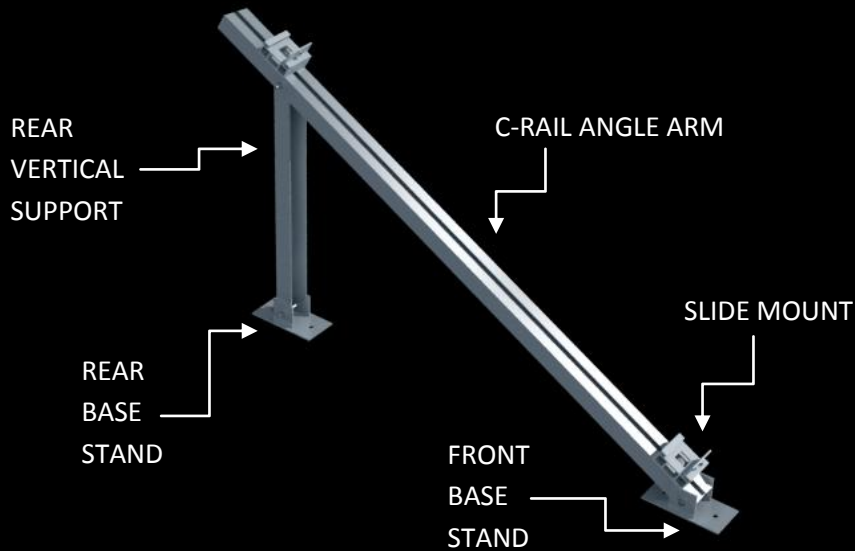

TOUGH TRAC

TOUGH TRAC™

MAPS Parts



FRONT & REAR BASE STANDS



C-RAIL ANGLE ARM

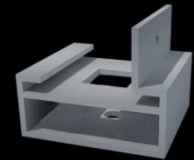

STD RAIL SLIDE MOUNT



CROSS BRACES

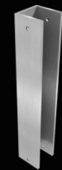

VERTICAL SUPPORT

Mid Angle Portrait System comprises the following parts:

- C Rail Angle Arms
- Front & Rear Base Stands
- Slide Mounts
- Cross Braces
- Standard Rail
- Connector Tubes
- Top Mount End Clamps
- Top Mount mid Clamps
- 1/4" x 1" Stainless Steel Bolts/Washers/Nuts
- 1/4" x 2" Stainless Steel Bolts/Washers/Nuts
- 1/4" x 3" Stainless Steel Bolts/Washers/Nuts
- Large & Small Rail Stainless Steel Bolts/Washers/Nuts
- T Bolt Rail Stainless Steel Bolts/Washers/Nuts
- Set Screws #14 x 1" Stainless

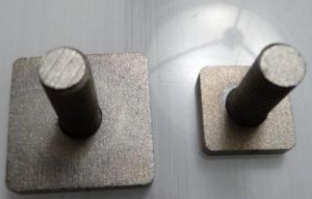

SQUARE RAIL BOLTS

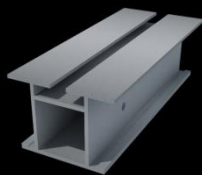

STANDARD RAIL



CONNECTOR TUBE

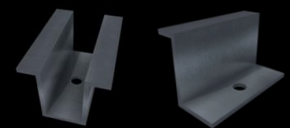

TOP MOUNT CLAMPS



FACTORY PRODUCTION FACILITIES: Made in the USA & China

VISIT US ONLINE AT WWW.TOUGHTRAC.COM

©COPYRIGHT 2009 TOUGH TRAC™. TRADEMARK BELONGS TO THEIR RESPECTIVE OWNERS. ALL RIGHTS RESERVED.



Mid Angle Portrait System

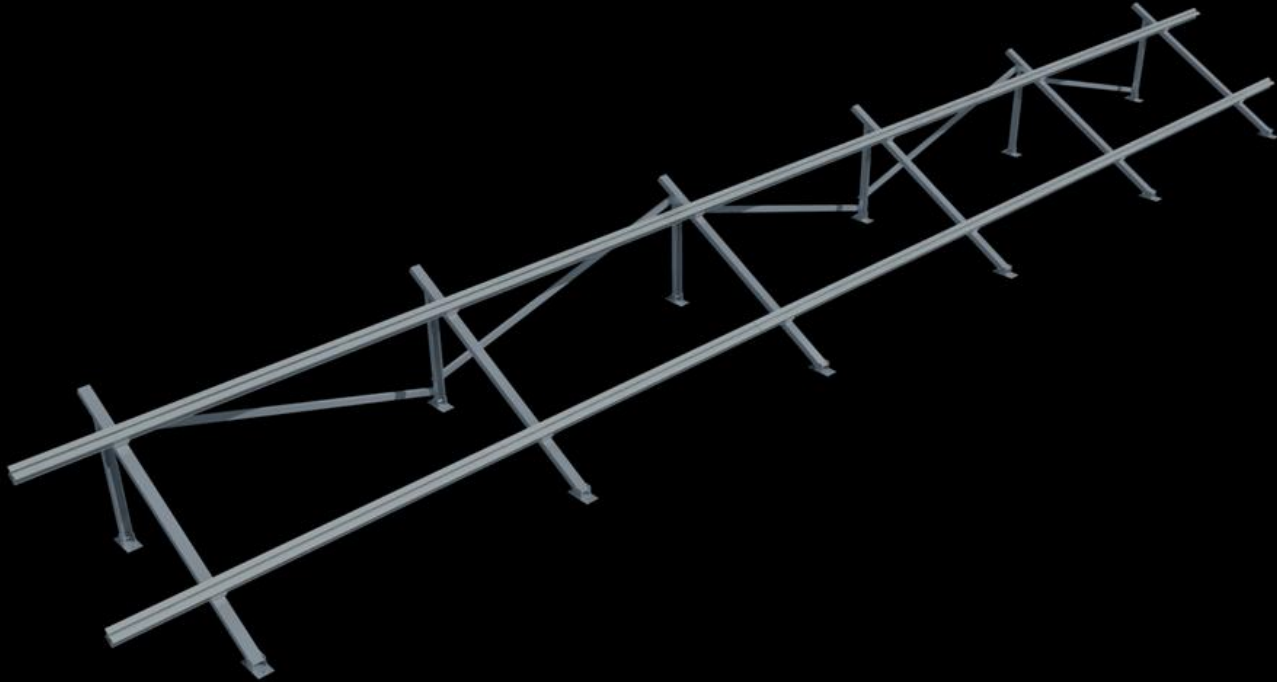

TOUGH TRAC

Component Specifications

Aluminum Rail & Parts: 6061 Aluminum China & 6005 Aluminum USA (Mill Finish)

Hardware Parts: 300 & 400 Series Stainless Steel

Code Compliant

PE Certified
TUV Tested
ISO Certified

Warranty

20 Years Limited Warranty

Technical Support

Installation Manual & Videos
Layout Design & Bill of Materials Calculated

Key Benefits:

- Lowest Priced MSRP in the market.
- Simple Installation and Ordering.
- Compatible with concrete curbs or concrete piers.
- No heavy machinery needed for installation.
- Rear Cross Brace keeps structure solid.
- Exclusive 2 rail design mounts any size panel and provides ultimate flexibility.
- Best in class spans for Standard Rail.
- Standard rail spans 96" for 120mph wind zones
- 100% all Aluminum Components and Stainless Steel Hardware.
- 20 Year Limited Warranty.



FACTORY PRODUCTION FACILITIES: Made in the USA & China

VISIT US ONLINE AT WWW.TOUGHTRAC.COM

©COPYRIGHT 2009 TOUGH TRAC™. TRADEMARK BELONGS TO THEIR RESPECTIVE OWNERS. ALL RIGHTS RESERVED.

